



For 2026

**NEW  
LOWER  
PRICING!**

[www.asagsales.com](http://www.asagsales.com)



Farm Supplies

Effective January 1, 2026

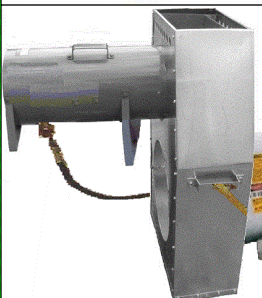

INTRODUCING:

**AGI** PRODUCT  
&  
**Sukup** HEATERS!

1-218-437-8200 Office  
1-218-689-5983 Cell





# Fans

## Axial Fans 3450 RPM

| Part Number | Dia. | HP   | PH | Control | Volts   | Wt. | Price    |
|-------------|------|------|----|---------|---------|-----|----------|
| 9850008     | 12"  | .75  | 1  | N       | 115/230 | 55  | \$ 1,110 |
| 9102136     | 12"  | 1    | 1  | N       | 115/230 | 56  | \$ 1,160 |
| 9747485     | 14"  | 1    | 1  | N       | 115/230 | 59  | \$ 1,280 |
| 9850032     | 18"  | 1.5  | 1  | N       | 230     | 109 | \$ 1,575 |
| 9744698     | 18"  | 3    | 1  | N       | 230     | 143 | \$ 1,700 |
| 9850065     | 18"  | 3    | 1  | Y       | 230     | 150 | \$ 2,145 |
| 9744656     | 18"  | 3    | 3  | N       | 230     | 143 | \$ 1,630 |
| 9850073     | 18"  | 3    | 3  | Y       | 230     | 150 | \$ 2,115 |
| 9850099     | 24"  | 5    | 1  | Y       | 230     | 208 | \$ 3,205 |
| 9850149     | 24"  | 10   | 1  | Y       | 230     | 250 | \$ 3,560 |
| 9850172     | 28"  | 12.5 | 1  | Y       | 230     | 297 | \$ 4,845 |

## Caldwell Fans

A name you can depend on.

**2 year**  
Limited warranty

If you don't see the fan you need listed, call and we will give you a price for that fan.

## In-Line Fans 3450 RPM



| Part Number | Dia. | HP  | PH | Control | Volts | Wt. | Price    |
|-------------|------|-----|----|---------|-------|-----|----------|
| 9778464     | 18"  | 3   | 1  | Y       | 230   | 148 | \$ 2,720 |
| 9778472     | 18"  | 3   | 3  | Y       | 230   | 148 | \$ 2,855 |
| 9779314     | 24"  | 5   | 1  | Y       | 230   | 230 | \$ 3,705 |
| 9779348     | 24"  | 5   | 3  | Y       | 230   | 212 | \$ 3,540 |
| 9783951     | 24"  | 7.5 | 1  | Y       | 230   | 249 | \$ 4,325 |
| 9778332     | 24"  | 7.5 | 3  | Y       | 230   | 245 | \$ 3,840 |
| 9779413     | 28"  | 10  | 1  | Y       | 230   | 283 | \$ 4,325 |
| 9774828     | 28"  | 15  | 3  | Y       | 230   | 339 | \$ 5,070 |

Must take delivery in a timely manner.

## Centrifugal Fans 1750 RPM



| Part Number | Dia.   | HP  | PH | Control | Volts | Type | Wt. | Price    |
|-------------|--|-----|----|---------|-------|------|-----|----------|
| 9743674     | 24"  | 5   | 1  | Y       | 230   | TEFC | 457 | \$ 5,690 |
| 9759712     | 24"  | 7.5 | 1  | Y       | 230   | TEFC | 492 | \$ 6,470 |
| 9401216     | 27"  | 10  | 1  | Y       | 230   | TEFC | 671 | \$ 7,220 |
| 9789826     | 27"  | 15  | 1  | Y       | 230   | ODP  | 695 | \$ 8,630 |
| 9743690     | 30"  | 20  | 3  | Y       | 230   | TEFC | 704 | \$ 8,065 |
| 9754135     | 30"  | 25  | 3  | Y       | 230   | TEFC | 835 | \$ 8,890 |
| 9736454     | Trans. for 5 - 15 HP, Size: 22" x 33" x 52" x 11 3/4"      |     |    |         |       |      | 102 | \$ 1,085 |
| 9736462     | Trans. for 20 - 25 HP, Size: 24 1/2" x 36" x 66" x 11 3/4" |     |    |         |       |      | 175 | \$ 1,200 |

[www.asagsales.com](http://www.asagsales.com)

A&S Ag Sales  
27411 370th St NW  
Argyle, MN 56713

1-218-437-8200  
or our cell phone  
1-218-689-5983

Prices subject to change without notice.



# Fans



## Axial Fans 3450 RPM

**AGI Fans**  
**1 year**  
**Limited warranty**

| Part Number | Dia. | HP | PH | Control | Volts | Wt. | Price    |
|-------------|------|----|----|---------|-------|-----|----------|
| GGX-80311AZ | 18"  | 3  | 1  | N       | 230   | 170 | \$ 1,510 |
| GGX-80311A  | 18"  | 3  | 1  | Y       | 230   | 175 | \$ 1,630 |
| GGX-80332AZ | 18"  | 3  | 3  | N       | 230   | 170 | \$ 1,590 |
| GGX-80332A  | 18"  | 3  | 3  | Y       | 230   | 175 | \$ 1,710 |
| GGX-80711AZ | 24"  | 5  | 1  | N       | 230   | 255 | \$ 2,190 |
| GGX-80711A  | 24"  | 5  | 1  | Y       | 230   | 260 | \$ 2,310 |

If you don't see the fan you need listed, call and we will give you a price for that fan.

## In-Line Fans 3450 RPM

| Part Number | Dia. | HP | PH | Control | Volts | Wt. | Price    |
|-------------|------|----|----|---------|-------|-----|----------|
| GGI-80311A  | 18"  | 3  | 1  | Y       | 230   | 175 | \$ 1,725 |
| GGI-80332A  | 18"  | 3  | 3  | Y       | 230   | 175 | \$ 1,865 |
| GGI-80511A  | 24"  | 5  | 1  | Y       | 230   | 265 | \$ 2,210 |
| GGI-80532A  | 24"  | 5  | 3  | Y       | 230   | 265 | \$ 2,295 |
| GGI-80711A  | 24"  | 7  | 1  | Y       | 230   | 265 | \$ 2,665 |
| GGI-80732A  | 24"  | 7  | 3  | Y       | 230   | 265 | \$ 2,750 |
| GGI-81011A  | 28"  | 10 | 1  | Y       | 230   | 350 | \$ 2,990 |
| GGI-81032A  | 28"  | 10 | 3  | Y       | 230   | 350 | \$ 3,070 |
| GGI-81532A  | 28"  | 15 | 3  | Y       | 230   | 390 | \$ 3,540 |



## Centrifugal Fans 3450 RPM & 1750 RPM

GGF is 3450 RPM



GGL is 1750 RPM



| Part Number | HP                                     | PH | Control | Volts | Air Outlet        | Wt. | Price    |
|-------------|--|----|---------|-------|-------------------|-----|----------|
| GGF-80311A  | 3                                      | 1  | Y       | 230   | 9" x 14"          | 175 | \$ 1,870 |
| GGF-80511A  | 5                                      | 1  | Y       | 230   | 9" x 14"          | 195 | \$ 2,415 |
| GGF-80711A  | 7.5                                    | 1  | Y       | 230   | 9" x 14"          | 235 | \$ 2,835 |
| GGF-81011A  | 10                                     | 1  | Y       | 230   | 12" x 17"         | 375 | \$ 3,690 |
| GGF-81032A  | 10                                     | 3  | Y       | 230   | 12" x 17"         | 375 | \$ 3,660 |
| GGL-80511A  | 5                                      | 1  | Y       | 230   | 14.375" x 27.5"   | 405 | \$ 3,975 |
| GGL-80711A  | 7.5                                    | 1  | Y       | 230   | 17.875" x 27.5"   | 520 | \$ 4,420 |
| GGL-81011A  | 10                                     | 1  | Y       | 230   | 16.875" x 30.25"  | 780 | \$ 4,810 |
| GGL-81532A  | 15                                     | 3  | Y       | 230   | 18.5" x 30.25"    | 660 | \$ 4,770 |
| GGL-82032A  | 20                                     | 3  | Y       | 230   | 19.75" x 33.375"  | 710 | \$ 5,915 |
| GGL-82532A  | 25                                     | 3  | Y       | 230   | 20.875" x 33.375" | 865 | \$ 7,010 |
| GGA-80137   | Trans. for 5 - 7 HP, Size: 40" x 11"   |    |         |       |                   | 95  | \$ 385   |
| GGA-80138   | Trans. for 10 - 15 HP, Size: 40" x 11" |    |         |       |                   | 95  | \$ 540   |
| GGA-80134   | Trans. for 20 - 25 HP, Size: 60" x 11" |    |         |       |                   | 175 | \$ 765   |

[www.asagsales.com](http://www.asagsales.com)

Must take delivery in a timely manner.

A&S Ag Sales 1-218-437-8200  
27411 370th St NW or our cell phone  
Argyle, MN 56713 1-218-689-5983

Prices subject to change without notice.



## Gas & Electric Heaters

| Part#   | DESCRIPTION    | BTU Output                                   | Fan required | Wt. | Price           |
|---------|----------------|--|--------------|-----|-----------------|
| 9157606 | H1015-LPGE-M   | 300,000 - 1,750,000                          | centrifugal  | 219 | <b>\$ 8,805</b> |
| 9157614 | H1015-NGE-PE   | 300,000 - 1,750,000                          | centrifugal  | 181 | <b>\$ 4,732</b> |
| 9270116 | H18-NGE-PE     | 120,000 - 900,000                            | axial        | 102 | <b>\$ 4,436</b> |
| 9114884 | H24-LPGE-M     | 250,000 - 2,100,000                          | axial        | 170 | <b>\$ 7,377</b> |
| 9285163 | H24-NGE-PE     | 250,000 - 2,100,000                          | axial        | 134 | <b>\$ 4,281</b> |
| 9141524 | HG28-LT-NGE-PE | 40,000 - 700,000                             | axial        | 148 | <b>\$ 4,542</b> |
| 9270181 | H28-LPGE-M     | 500,000 - 3,000,000                          | axial        | 186 | <b>\$ 7,729</b> |
| 9285155 | H28-NGE-PE     | 500,000 - 3,000,000                          | axial        | 150 | <b>\$ 4,705</b> |
| 9146501 | ILCH18-VPGE    | 31,000 - 135,000                             | In-line      | 86  | <b>\$ 3,486</b> |
| 9143212 | ILCH24-VPGE    | 31,000 - 135,000                             | In-line      | 120 | <b>\$ 3,562</b> |
| 9143220 | ILCH28-VPGE    | 31,000 - 135,000                             | In-line      | 134 | <b>\$ 3,574</b> |
| 9850974 | HTC            | Humidistat/Thermostat                        | All Heaters  | 10  | <b>\$ 689</b>   |
| 9851014 | TC             | Thermostat w/Cord Control Setting 40° - 200° | All Heaters  | 10  | <b>\$ 471</b>   |



For Axial,  
In-Line, and  
Centrifugal  
Fans.

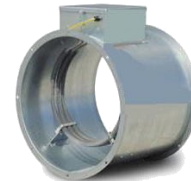

## Downstream / Upstream Heaters



Vapor Propane -  
Super Low and  
Low Temperature  
Heaters.

| Part Number | Dia. | Hp     | Fan   | Btu/hr  | Temp Rise | Model # | Wt. | Price           |
|-------------|------|--------|-------|---------|-----------|---------|-----|-----------------|
| D4681       | 18"  | -      | Axial | 0.3 MM  | 10-30°F   | VS18V-T | 125 | <b>\$ 2,900</b> |
| D4731       | 18"  | -      | Axial | 0.42 MM | 25-75°F   | VL18V-T | 125 | <b>\$ 2,900</b> |
| D4781       | 24"  | -      | Axial | 0.5 MM  | 10-30°F   | VS24V-T | 150 | <b>\$ 3,055</b> |
| D4731       | 24"  | -      | Axial | 0.72 MM | 25-75°F   | VL24V-T | 150 | <b>\$ 3,055</b> |
| D4881       | 28"  | -      | Axial | 1.0 MM  | 10-30°F   | VS28V-T | 160 | <b>\$ 3,210</b> |
| D4831       | 28"  | -      | Axial | 1.44 MM | 25-75°F   | VL28V-T | 160 | <b>\$ 3,210</b> |
| D4181       | -    | 7.5-15 | Cent. | 0.3 MM  | 10-30°F   | DS10V-T | 140 | <b>\$ 3,295</b> |
| D4131       | -    | 7.5-15 | Cent. | 0.72 MM | 25-75°F   | DL10V-T | 140 | <b>\$ 3,295</b> |
| D4281       | -    | 20-30  | Cent. | 0.5 MM  | 10-30°F   | DS20V-T | 163 | <b>\$ 3,565</b> |
| D4231       | -    | 20-30  | Cent. | 0.72 MM | 25-75°F   | DL20V-T | 163 | <b>\$ 3,565</b> |



## Downstream Heaters



| Part#    | Description       | BTU Output | Fan required      | Wt. | Price           |
|----------|-------------------|------------|-------------------|-----|-----------------|
| GGH-8350 | Heater LT 9"x14"  | 60,000     | 3Hp High Speed    | 36  | <b>\$ 1,755</b> |
| GGH-8351 | Heater LT 9"x14"  | 100,000    | 5-7.5Hp Full Cent | 36  | <b>\$ 2,075</b> |
| GGH-8352 | Heater LT 18" Rd  | 60,000     | 3Hp Inline        | 44  | <b>\$ 1,950</b> |
| GGH-8353 | Heater LT 24" Rd  | 100,000    | 5-7.5Hp Inline    | 60  | <b>\$ 2,305</b> |
| GGH-8354 | Heater LT 12"x17" | 200,000    | 10Hp Full Cent    | 64  | <b>\$ 2,380</b> |
| GGH-8355 | Heater LT 28" Rd  | 200,000    | 10Hp Inline       | 127 | <b>\$ 2,540</b> |

Low Temp Propane/Natural Gas Heaters.

[www.asagsales.com](http://www.asagsales.com)

|                   |                   |
|-------------------|-------------------|
| A&S Ag Sales      | 1-218-437-8200    |
| 27411 370th St NW | or our cell phone |
| Argyle, MN 56713  | 1-218-689-5983    |

Prices subject to change without notice.



# LOCK -n- LOAD FLOOR

Floor Price includes all required planking, supports, flashing and hardware.  
(pricing based on 7 rings tall bin; taller bins will need to be quoted)



**AGI Westeel  
Lock-n-Load  
floor supports.**



**NOTE:  
Call for other size  
bins not listed.**

| Floor Kit<br>P/N | Bin<br>Dia. | Floor Type<br>Cereal - .094<br>Canola - .054 | Weight<br>Lbs. | Price     |
|------------------|-------------|--|----------------|-----------|
| FF1507CER14      | 15'         | Cereal                                       | 1006           | \$ 2,135  |
| FF1507CAN14      | 15'         | Canola                                       | 996            | \$ 2,175  |
| FF1807CER14      | 18'         | Cereal                                       | 1407           | \$ 2,925  |
| FF1807CAN14      | 18'         | Canola                                       | 1393           | \$ 2,985  |
| FF2107CER14      | 21'         | Cereal                                       | 1850           | \$ 3,730  |
| FF2107CAN14      | 21'         | Canola                                       | 1831           | \$ 3,815  |
| FF2407CER14      | 24'         | Cereal                                       | 2421           | \$ 4,860  |
| FF2407CAN14      | 24'         | Canola                                       | 2396           | \$ 4,970  |
| FF2707CER14      | 27'         | Cereal                                       | 3024           | \$ 5,985  |
| FF2707CAN14      | 27'         | Canola                                       | 2992           | \$ 6,125  |
| FF3007CER14      | 30'         | Cereal                                       | 3840           | \$ 7,465  |
| FF3007CAN14      | 30'         | Canola                                       | 3800           | \$ 7,635  |
| FF3307CER14      | 33'         | Cereal                                       | 4648           | \$ 9,090  |
| FF3307CAN14      | 33'         | Canola                                       | 4600           | \$ 9,295  |
| FF3607CER14      | 36'         | Cereal                                       | 5457           | \$ 10,540 |
| FF3607CAN14      | 36'         | Canola                                       | 5399           | \$ 10,790 |
| FF4207CER14      | 42'         | Cereal                                       | 7572           | \$ 14,575 |
| FF4207CAN14      | 42'         | Canola                                       | 7494           | \$ 14,905 |
| FF4807CER14      | 48'         | Cereal                                       | 9831           | \$ 18,775 |
| FF4807CAN14      | 48'         | Canola                                       | 9727           | \$ 19,215 |

**L&J Industries floor supports  
also available.**



**Chief floor supports and flashing.**

| Model<br>Number | Description  | Ship<br>Wt. Lbs. | Price | Qty<br>Order |
|-----------------|--------------|------------------|-------|--------------|
| 9140636         | 12" Support  | 2.5              | \$ 10 |              |
| 9736660         | 13" Support  | 3                | \$ 11 |              |
| 9736520         | 10" Flashing | 1.5              | \$ 7  |              |







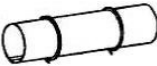
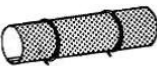

[www.asagsales.com](http://www.asagsales.com)

Prices subject to change without notice.

# AERATION DUCT and FLUSH FLOOR



| AERATION SYSTEMS<br>12" Round Duct Components<br>And Accessories                   |                    |  |     |       |
|--|--------------------|--|-----|-------|
|  | Number             | Description  | Wt. | Price |
|   | 9852475            | 12" Flanged wall Inlet Adaptor<br>Slips into 12" Fan       | 11  | \$107 |
|   | 9852517            | 12" Solid Duct<br>4' Long 22 Ga.<br>Interlocking Seam      | 16  | \$58  |
|   | 9852525            | 12" Perforated Duct<br>4' Long 20 Ga.<br>Interlocking Seam | 18  | \$73  |
|   | 9852541<br>(Black) | 12" Reinforcement Ring (Two per 4' Length of Duct)         | 3   | \$21  |
|   | 9852467            | 12" Solid End Cap  | 2   | \$18  |
|   | 9852558            | 12" Perforated End Cap                                     | 2   | \$13  |
|   | 9733964            | 12" Y - Box  | 26  | \$406 |
|  | 9770339            | 12" 4 Way Cross  | 21  | \$420 |







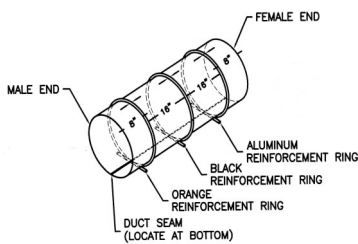

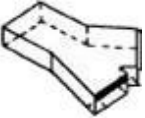

| AERATION SYSTEMS<br>18" Round Duct Components<br>And Accessories                   |  |   |     |                      |
|--|--|---|-----|----------------------|
|  | Number   | Description   | Wt. | Price                |
|   | 9852624  | 18" Flanged wall Inlet Adaptor<br>Slips into 18" Fan          | 21  | \$186                |
|   | 9852657  | 18" Solid Duct<br>4' Long 22 Ga.<br>Interlocking Seam         | 24  | \$75                 |
|   | 9756809<br>(Canola)                            | 18" Perforated Duct<br>4' Long 20 Ga.<br>Interlocking Seam    | 26  | \$93                 |
|   | 9852681 (Al)<br>9852699 (Blk)<br>9852707 (Org) | 18" Reinforcement Ring (3 Rings per 4' Duct -1 of each color) | 7   | \$29<br>\$29<br>\$29 |
|   | 9852616  | 18" Solid End Cap   | 3   | \$23                 |
|   | 9776153<br>(Canola)                            | 18" Perforated End Cap  | 3   | \$30                 |
|   | 9735472  | 18" Y - Box   | 45  | \$498                |
|  | 9735985  | 18" 4 Way Cross   | 38  | \$589                |

**NOTES:**

Fan should be supported when using Standard transitions. It can be suspended in air when using the raised transitions. Standard transitions are manufactured with a 12" hole and must be field cut when using a 14" or 18" fan. These systems are designed for grain depth up to 22'.

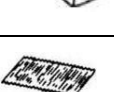

## Flush Floor Aeration

|   | Part Number | Description                                      | Wt. (Lbs.) | Price |
|---|-------------|--|------------|-------|
|  | 9853325     | Flush Floor Y                                    | 55         | \$575 |
|  | 9853333     | Y Fan Trans.                                     | 37         | \$527 |
|  | 9853341     | Std. Fan Trans.                                  | 44         | \$570 |
|  | 9853358     | 12" Raised Y Fan Trans. w/Angle Ring Flange      | 44         | \$589 |
|  | 9853366     | 18" Raised Y Fan Trans. w/Angle Ring Flange      | 45         | \$603 |
|  | 9853382     | 10' Form   | 42         | \$125 |
|  | 9853390     | 4' Form  | 17         | \$62  |
|  | 9853408     | 2' Form  | 8          | \$32  |
|  | 9853424     | Corrugated-Perforated 18 Ga. Floor Sheet 20"x45" | 13         | \$39  |
|  | 9853432     | Corrugated-Solid 18 Ga. Floor Sheet 20"x 45"     | 15         | \$52  |
|  | 9853457     | Solid End Plate                                  | 3          | \$21  |

[www.asagsales.com](http://www.asagsales.com)

Must take delivery in a timely manner.

Prices subject to change without notice.

## Temporary Storage

| Part#     | Model Size      | Bushels | Wt.   | Price     |
|-----------|-----------------|---------|-------|-----------|
| 9348134   | One Ring 49'6"  | 12,744  | 1,122 | \$ 3,067  |
| 9348136   | One Ring 74'3"  | 36,611  | 2,087 | \$ 6,070  |
| 9348140   | One Ring 105'2" | 93,391  | 4,480 | \$ 11,893 |
| 9348135   | Two Ring 49'6"  | 18,431  | 2,045 | \$ 5,105  |
| 9348137   | Two Ring 74'3"  | 49,409  | 4,100 | \$ 10,124 |
| 9348141   | Two Ring 105'2" | 119,074 | 9,103 | \$ 20,845 |
| TARP-496  | 49'6"           | -       | 114   | \$ 1,838  |
| TARP-743  | 74'3"           | -       | 237   | \$ 3,772  |
| TARP-1052 | 105'2"          | -       | 449   | \$ 7,063  |



Package includes 42" Titan Chief bin sheets, bolts, angle ring, & anchors.

Bottom Tarps also available.



### Caldwell Grain Bin Roof Exhaust Fans

| Model#     | Part#   | Dia. | HP  | PH | Voltage | CFM    | WT. | Price    |
|------------|---------|------|-----|----|---------|--------|-----|----------|
| RFG-18.51  | 9755306 | 18"  | 0.5 | 1  | 115/230 | 4,000  | 104 | \$ 2,087 |
| RFG-18.53  | 9755314 | 18"  | 0.5 | 3  | 230/460 | 4,000  | 106 | \$ 1,968 |
| SVR24-21NC | 9732306 | 24"  | 2   | 1  | 230     | 10,650 | 180 | \$ 2,328 |
| SVR24-23NC | 9732302 | 24"  | 2   | 3  | 230/460 | 10,650 | 170 | \$ 1,970 |

### AGI Grain Bin Roof Exhaust Fans

| Part #      | Explosion Proof | HP | PH | Voltage | WT. | Price    |
|-------------|-----------------|----|----|---------|-----|----------|
| GGE-80211A  | No              | 2  | 1  | 230     | 177 | \$ 2,760 |
| GGE-80211AH | Yes             | 2  | 1  | 230     | 189 | \$ 4,875 |
| GGE-80232A  | No              | 2  | 3  | 230     | 177 | \$ 2,760 |
| GGE-80232AH | Yes             | 2  | 3  | 230     | 178 | \$ 3,550 |



SA-105

All spreaders are adjustable to fit bin openings of 22" to 30"

Larger bin openings (up to 60") require additional brackets.

SA-32 price is \$ 235.

### Spread-All Grain Bin Spreaders

| Part #         | Capacity  | Bin Size  | Hp  | Volts | Wt. | Price    |
|----------------|---|-----------|-----|-------|-----|----------|
| SA-97 (E-3)    | For 10" Auger, 3,000 to 5,000 bu/hr w/ reversing switch | Up to 36' | 1/2 | 115   | 85  | \$ 2,295 |
| SA-97HS (E-3)  | For 10" Auger, 3,000 to 5,000 bu/hr w/ reversing switch | Up to 42' | 1   | 115   | 100 | \$ 2,420 |
| SA-103 (E-6)   | For 13" Auger, 6,000 to 9,000 bu/hr w/ reversing switch | Up to 36' | 1   | 115   | 100 | \$ 2,920 |
| SA-104HS (E-6) | For 13" Auger, 6,000 to 9,000 bu/hr w/ reversing switch | 42' plus  | 1   | 115   | 100 | \$ 3,095 |
| SA-98          | Stationary Gravity Spreader 3,000 bu/hr                 | Up to 18' | -   | -     | 18  | \$ 260   |
| SA-105         | Spinning Gravity Spreader 3,000 to 5,000 bu/hr          | Up to 30' | -   | -     | 55  | \$ 910   |
| SA-106         | Spinning Gravity Spreader 6,000 to 9,000 bu/hr          | Up to 30' | -   | -     | 55  | \$ 910   |
| SA-107         | Spinning Gravity Spreader 10,000 to 15,000 bu/hr        | 30' plus  | -   | -     | 65  | \$ 1,340 |

Optional SA-32 shown here



SA-97 (E-3)

Reversing switch to change from narrow to wide spread.

3 phase motors are also available.

Prices subject to change without notice.

# GRAIN BIN MONITORING EQUIPMENT

**AGI BINMANAGER®**

## FULL AUTOMATION

SAFETY VISIBILITY AUTOMATION PROFITABILITY

**AGI BINMONITOR™**

## REMOTE VISIBILITY

SAFETY VISIBILITY SECURITY PROFITABILITY



### WE SERVICE THE TRI-STATE REGION



ND & SD farmers call **Casey Gajeski at 218-791-8093**

MN farmers call **Nic Thompson at 218-201-1737**

They are more than happy to answer any questions you may have about BinManager!

### Customer Testimonials-

*"I know exactly what's going on inside my bin."*

*"You guys have saved me so much money."*

*"This is like autosteer for grain bins."*

*"I don't have to guess anymore."*

*"I need this in everyone of my bins."*

*"This has solved so many of my problems."*

*"I have so much peace of mind now."*

### "Seeing" inside your grain bin!

Each cable has a temperature and moisture sensor every 2 feet and the larger the diameter bin the more cables you can have.

The BinManager will automatically run the fans and heaters based on your desired settings and outside conditions.

The BinMonitor will only give you visibility into your bin. Fans and heaters can only run manually.

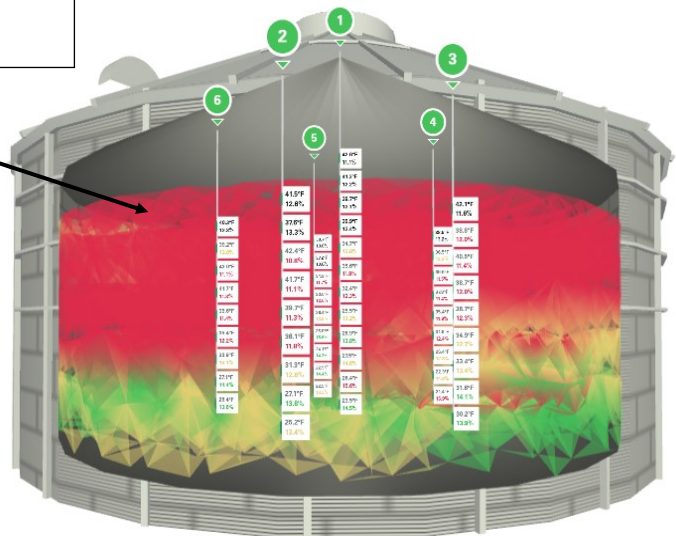



# GRAIN BINS

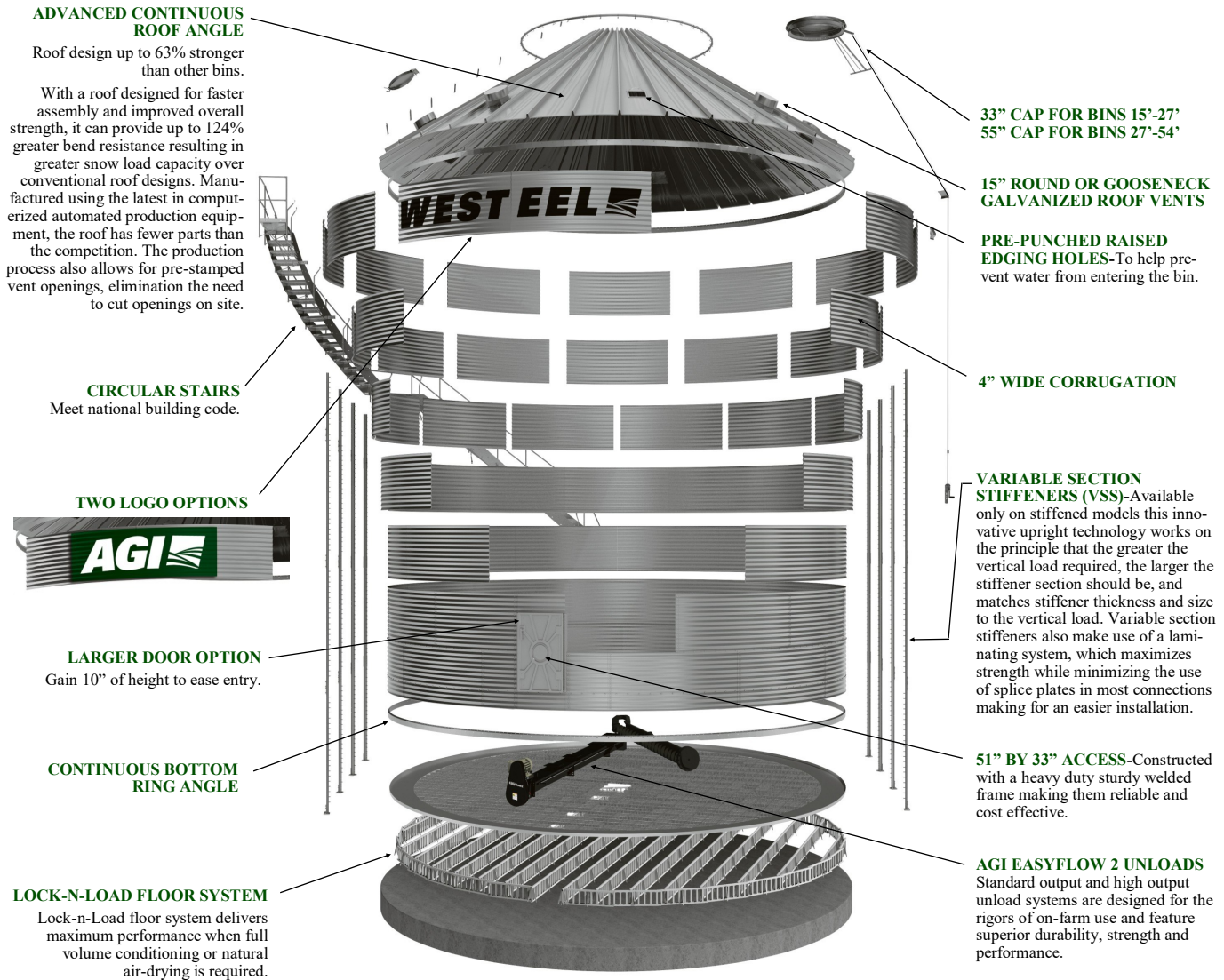

We are also a



Dealer.

Financing available

For your storage needs please call!

Reece Setterholm at 218-280-5890

Dustin Isaak at 218-686-5979

Office at 218-437-8200

# FARM SUPPLIES

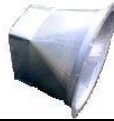

| Part#   | <u>Qty Order</u> | Description           | Diameter           | Price  |
|---------|------------------|-----------------------|--------------------|--------|
| 9851873 |                  | Angle Ring            | 12"                | \$ 66  |
| 9747790 |                  | Angle Ring            | 14"                | \$ 39  |
| 9851881 |                  | Angle Ring            | 18"                | \$ 57  |
| 9851899 |                  | Angle Ring            | 24"                | \$ 62  |
| 9701011 |                  | Angle Ring            | 28"                | \$ 76  |
| T1871   |                  | Transition            | 18"                | \$ 425 |
| T2411   |                  | Transition            | 24"                | \$ 548 |
| T2811   |                  | Transition            | 28"                | \$ 628 |
| T129-R  |                  | Conversion to Keho    | 12" round - 9"x14" | \$ 248 |
| T189-R  |                  | Conversion to Keho    | 18" round - 9"x14" | \$ 308 |
| T249-R  |                  | Conversion to Keho    | 24" round - 9"x14" | \$ 377 |
| T129-T  |                  | Conversion to Edwards | 12" round - 9"x14" | \$ 248 |
| T189-T  |                  | Conversion to Edwards | 18" round - 9"x14" | \$ 308 |
| T249-T  |                  | Conversion to Edwards | 24" round - 9"x14" | \$ 377 |
| T1288   |                  | Reducer               | 12-12              | \$ 115 |
| T1412   |                  | Reducer               | 14-12              | \$ 143 |
| T1812   |                  | Reducer               | 18-12              | \$ 193 |
| T2412   |                  | Reducer               | 24-12              | \$ 288 |
| T24182  |                  | Reducer               | 24-18              | \$ 468 |
| T28242  |                  | Reducer               | 28-24              | \$ 518 |

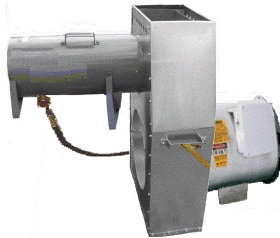

**Low Temp  
Variable Heater  
Grain Drying System**

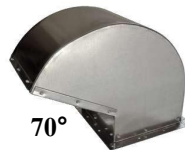

| <u>Model#</u> | <u>QTY. ORDER</u> | <u>Price</u> |
|---------------|-------------------|--------------|
| MSI75-125     |                   | \$ 1,285     |

**Model# MSI75-125**  
( Heater and Mixer Only )

**Features**

- Mounts on the upstream side of any configuration of fans without separating the fan from the ducting.
- Heater and mixer can be carried by one person.
- Install in minutes using the load binder mounting system.
- 75,000 to 125,000 BTU variable heater.
- Comes with 10' hose and regulator.
- Uses Propane Vapor only.
- Optimum temperature rise is 5° to 40° F above the outside air temperature depending on the time of year and fan size ( 1 1/2 hp minimum to 15 hp maximum ) used.
- 1 year limited warranty.

**GOOSENECK ROOF VENTS**

**70° Vent Part# GS-1270 \$ 112 ea.**  
Bird proof screen, 15"X15" Base  
Packaged 2/box.

**70° Vent Part# GS-1570 \$ 127 ea.**  
Bird proof screen, 18"X18" Base  
Packaged 2/box.

**LOW PROFILE ROOF VENTS**

**Curved Vent Part# T329 \$ 183 ea.**  
7" x 32" Low Profile Tapered  
Packaged 1/box



**Prices subject to change without notice.**

[www.asagsales.com](http://www.asagsales.com)

**Never climb your bins again!**

**LevALERT Bin Level Indicator**



When your bin material reaches the LevALERT™ indicator, it pushes against the rubber activator, turning the color tube from black to a bright yellow color. When material recedes, it automatically darkens again - ready for the next fill.

Shipping weight 4 lbs.....**Part# LEV-760.....\$159**



**REMOTE BIN LIDS**

Easy to open spring loaded closure.

**NOTE:**

One **Part# CK40** is required for each L20 - L25 Lid.



**BNF27** - Convert Small Center Hole to larger 27" opening.

| Part# | Description  | Wt. | Price  |
|-------|--|-----|--------|
| L18   | INLAND, Opening-16", Lid Size-18"                              | 18  | \$ 249 |
| L20   | INLAND, Opening-18", Lid Size-20"                              | 20  | \$ 249 |
| L22   | WESTEEL ROSCO, Opening-20", Lid Size-22"                       | 22  | \$ 249 |
| L24   | BUTLER/GOEBEL, Opening-22 1/4", Lid Size-24"                   | 25  | \$ 269 |
| L25   | BUTLER, Opening-22 1/4"-23 3/4", Lid Size-25"                  | 26  | \$ 269 |
| L27   | MCCLEOD, Opening-25", Lid Size-27"                             | 29  | \$ 373 |
| L29   | BEHLEN, Opening-27 1/4", Lid Size-29"                          | 33  | \$ 373 |
| L30   | Bin Lid, Opening-28", Lid Size-30",                            | 37  | \$ 453 |
| L32   | Bin Lid, Opening-30", Lid Size-32", (*)                        | 41  | \$ 562 |
| L33   | Bin Lid, Opening-31", Lid Size-33", (*)                        | 45  | \$ 562 |
| L34   | Bin Lid, Opening-32", Lid Size-34", (*)                        | 50  | \$ 562 |
| L36   | Bin Lid, Opening-34", Lid Size-36", (*)                        | 56  | \$ 562 |
| L38   | Bin Lid, Opening-36", Lid Size-38", (*)                        | 64  | \$ 562 |
| L40   | Bin Lid, Opening-38.625", Lid Size-40", (*)                    | 71  | \$ 711 |
| L42   | Bin Lid, Opening-39.625", Lid Size-42", (*)                    | 80  | \$ 711 |
| CK40  | Cable Kit Replacement #3/32 cable                              | 2   | \$ 14  |
| CK55  | Cable Kit Replacement #3/32 cable,                             | 2   | \$ 14  |
| R30   | Reducers 30", Opening-27 1/4", Lid Size-29"                    | 17  | \$ 271 |
| R32   | Reducers 32", Opening-27 1/4", Lid Size-29"                    | 18  | \$ 271 |
| R34   | Reducers 34", Opening-27 1/4", Lid Size-29"                    | 19  | \$ 271 |
| R36   | Reducers 36", Opening-27 1/4", Lid Size-29"                    | 27  | \$ 271 |
| R37   | Reducers 37", Opening-27 1/4", Lid Size-29"                    | 28  | \$ 304 |
| BRK   | Brock Reducer, 39 5/8" w/2" Lip, Opening-39 1/2", Lid Size-29" | 29  | \$ 382 |
| R40   | Reducers 40", Opening-27 1/4", Lid Size-29"                    | 32  | \$ 389 |
| R42   | Reducers 42", Opening-27 1/4", Lid Size-29"                    | 29  | \$ 389 |
| R46   | Reducers 46", Opening-27 1/4", Lid Size-29"                    | 40  | \$ 453 |
| SM    | SM StorMor Reducer, 36 1/2" Flange, Opening-23", Lid Size-25"  | 28  | \$ 304 |
| LG    | LG StorMor Reducers, 44" Flange, Opening-27 1/4", Lid Size-29" | 35  | \$ 382 |
| XLG   | LG StorMor Reducers, 53" Flange, Opening-27 1/4", Lid Size-29" | 50  | \$ 382 |
| MFS   | MFS Reducer, 48" Flange, Opening-27 1/4", Lid Size-29"         | 45  | \$ 382 |
| BNF27 | Bin Neck W/Flange, Opening-27 1/4", Lid Size-29"               | 40  | \$ 271 |
| LWS   | Lid Winch Stainless  | 4   | \$ 60  |

**Freight:** F.O.B Argyle, MN  
**218-437-8200 Office**  
**218-689-5983 Cell**

(\*) All Lids L27 through L42 lids include lid braces, lid winch and CK55.

Must take delivery in a timely manner.

Prices subject to change without notice.

# Grain Saver Unloading Equipment

## Horizontal Powerheads

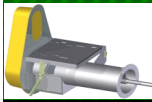

The Innovative motor mount is the easy off style and has the over center belt tightener as standard. The 2-belt cast aluminum driven sheave, the drive belt(s), and the belt guard are all included.

| 6" Horizontal Powerhead |     |       | 8" Horizontal Powerhead |     |       | 10" Horizontal Powerhead |     |         |
|-------------------------|-----|-------|-------------------------|-----|-------|--------------------------|-----|---------|
| Part#                   | Wt. | Price | Part#                   | Wt. | Price | Part#                    | Wt. | Price   |
| 602-00-1102             | 92  | \$865 | 802-00-1102             | 94  | \$865 | 102-00-1102              | 115 | \$1,023 |

## Unload Screws



Unload screws are all right hand, full pitch and are welded to the screw shaft every 1 - 1/2 pitches. Drilled to fit most power head output shafts. Never start and stop auger under full load.

| Bin  |           | 8"          |     |       | 10"         |     |       |
|------|-----------|-------------|-----|-------|-------------|-----|-------|
| Dia. | Length    | Part#       | Wt. | Price | Part#       | Wt. | Price |
| 19"  | 11' - 10" | 800-19-3010 | 48  | \$299 |             |     |       |
| 21"  | 12' - 10" | 800-21-3010 | 52  | \$324 |             |     |       |
| 24"  | 14' - 4"  | 800-24-3010 | 58  | \$387 | 100-24-3007 | 86  | \$549 |
| 27"  | 15' - 10" | 800-27-3010 | 64  | \$399 | 100-27-3007 | 96  | \$569 |
| 30"  | 17' - 4"  | 800-30-3010 | 70  | \$436 | 100-30-3007 | 105 | \$625 |
| 33"  | 18' - 10" | 800-33-3010 | 76  | \$474 | 100-33-3007 | 114 | \$674 |
| 36"  | 20' - 4"  | 800-36-3010 | 82  | \$512 | 100-36-3007 | 123 | \$729 |
| 42"  | 23' - 4"  | 800-42-3010 | 94  | \$586 | 100-42-3007 | 141 | \$898 |
| 48"  | 26' - 4"  | 800-48-3010 | 106 | \$658 | 100-48-3007 | 159 | \$993 |

## Double Hopper Unload Tube



Bin unload tubes are completely assembled and ready for installation in either a poured concrete foundation, or installed under a drying/aeration floor. Roller slide gates, sweep pivot pin, control rods, rodent cover and an industrial enamel finish are all included as standard equipment.

| Bin       |          | 8"          |     |         | 10"         |     |         |
|-----------|----------|-------------|-----|---------|-------------|-----|---------|
| Dia.      | Length   | Part#       | Wt. | Price   | Part#       | Wt. | Price   |
| 18" - 19" | 12' - 0" | 800-19-1002 | 187 | \$1,307 |             |     |         |
| 21'       | 13' - 0" | 800-21-1002 | 194 | \$1,359 |             |     |         |
| 24'       | 14' - 6" | 800-24-1002 | 212 | \$1,477 | 100-24-1002 | 234 | \$1,725 |
| 27'       | 16' - 0" | 800-27-1002 | 222 | \$1,534 | 100-27-1002 | 248 | \$1,841 |
| 30'       | 17' - 6" | 800-30-1002 | 232 | \$1,667 | 100-30-1002 | 257 | \$1,926 |
| 33'       | 19' - 0" | 800-33-1002 | 242 | \$1,726 | 100-33-1002 | 269 | \$2,042 |
| 36'       | 20' - 6" | 800-36-1002 | 252 | \$1,781 | 100-36-1002 | 281 | \$2,126 |
| 42'       | 23' - 6" | 800-42-1002 | 272 | \$1,926 | 100-42-1002 | 305 | \$2,326 |
| 48'       | 26' - 6" | 800-48-1002 | 285 | \$2,071 | 100-48-1002 | 330 | \$2,506 |

## 25 Degree Inclined Powerheads



Inclined Powerheads are complete with electric motor mount, driven pulley, drive belts and drive shields. Support Stands are at an extra cost.

| DESCRIPTION                       | PART#       | Wt. | Price   |
|-----------------------------------|-------------|-----|---------|
| 6" to 8" Inclined Powerhead       | 602-68-4002 | 166 | \$1,530 |
| 6" to 8" Inclined Support Stand   | 602-IS-4002 | 23  | \$288   |
| 8" to 10" Inclined Powerhead      | 802-81-4002 | 216 | \$1,777 |
| 8" to 10" Inclined Support Stand  | 802-IS-4002 | 24  | \$298   |
| 10" to 12" Inclined Powerhead     | 102-11-4002 | 265 | \$2,513 |
| 10" to 12" Inclined Support Stand | 102-IS-4002 | 26  | \$309   |

## Unload Tube Accessories

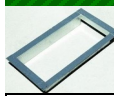

Bin wall plates flash the area in the bin wall when an opening is cut to accommodate an unload tube. Hopper flanges flash the area in the drying/aeration floor, where

| Description             | 8"          |     |       | 10"         |     |       |
|-------------------------|-------------|-----|-------|-------------|-----|-------|
|                         | Part#       | Wt. | Price | Part#       | Wt. | Price |
| Bin Wall plate          | 800-14-2000 | 7   | \$48  | 100-16-2000 | 11  | \$48  |
| Hopper Flange (12x24x2) | 200-24-2002 | 8   | \$52  | 200-24-2002 | 8   | \$52  |

## Center Sump Clump Buster

Fits over most Center Sumps for Grain Bin Unload Tubes and Powersweeps.



| Center Sump Clump Buster |     |       |
|--------------------------|-----|-------|
| Part#                    | Wt. | Price |
| 102-CB-1100              | 30  | \$251 |

## Upper and Lower Gearboxes for Powersweeps

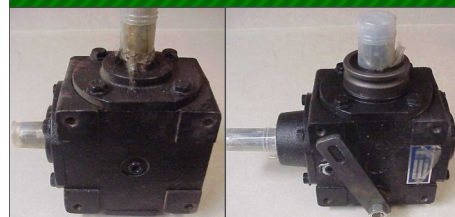

|             |                              |       |
|-------------|------------------------------|-------|
| 002-00-4001 | Lower Gearbox for Powersweep | \$618 |
| 002-00-4002 | Upper Gearbox for Powersweep | \$565 |

Must take delivery in a timely manner.

Prices subject to change without notice.

Freight: F.O.B Argyle, MN  
218-437-8200 Office  
218-689-5983 Cell

# Grain Saver Powersweep Parts

## Bin Sweeps (electric)



Bin Sweeps include the formed steel backboard, drive wheel, easy off motor mount, driven sheaves, belts and belt guard. Use smallest diameter motor sheave that can be installed on the drive motor, this allows for slower sweep auger rotation.

| Dia.  | 5" for 6" tubes |     |         |     | 5" for 8" tubes |     |         |     | 7" for 10" tubes |     |         |     |
|-------|-----------------|-----|---------|-----|-----------------|-----|---------|-----|------------------|-----|---------|-----|
|       | Part#           | Wt. | Price   | HP  | Part#           | Wt. | Price   | HP  | Part#            | Wt. | Price   | HP  |
| 18'   | 502-22-1100     | 86  | \$983   | 1.5 | 502-22-1100     | 86  | \$983   | 1.5 | 702-22-1100      | 91  | \$1,163 | 2.0 |
| 19'   | 502-22-1100     | 86  | \$983   | 1.5 | 502-22-1100     | 86  | \$983   | 1.5 | 702-22-1100      | 91  | \$1,163 | 2.0 |
| 21'   | 502-22-1100     | 86  | \$983   | 2.0 | 502-22-1100     | 86  | \$983   | 2.0 | 702-22-1100      | 91  | \$1,163 | 2.0 |
| 24'   | 502-27-1100     | 109 | \$1,073 | 2.0 | 502-27-1100     | 109 | \$1,073 | 2.0 | 702-27-1100      | 110 | \$1,606 | 3.0 |
| 27'   | 502-27-1100     | 109 | \$1,073 | 2.0 | 502-27-1100     | 109 | \$1,073 | 2.0 | 702-27-1100      | 110 | \$1,606 | 3.0 |
| 30'   | 502-36-1100     | 149 | \$1,263 | 3.0 | 502-36-1100     | 149 | \$1,263 | 3.0 | 702-36-1100      | 155 | \$1,646 | 5.0 |
| 33'   | 502-36-1100     | 149 | \$1,263 | 3.0 | 502-36-1100     | 149 | \$1,263 | 3.0 | 702-36-1100      | 155 | \$1,646 | 5.0 |
| 36'   | 502-36-1100     | 149 | \$1,263 | 3.0 | 502-36-1100     | 149 | \$1,263 | 3.0 | 702-36-1100      | 155 | \$1,646 | 5.0 |
| 42'   | 502-42-1100     | 169 | \$1,716 | 3.0 | 502-42-1100     | 169 | \$1,716 | 3.0 | 702-42-1100      | 178 | \$1,991 | 5.0 |
| 48'   | 502-48-1100     | 199 | \$2,080 | 3.0 | 502-48-1100     | 199 | \$2,080 | 3.0 | 702-48-1100      | 202 | \$2,149 | 5.0 |
| wheel | 702-00-0010     | 8   | \$105   |     | 702-00-0010     | 8   | \$105   |     | 902-00-0010      | 10  | \$118   |     |

## Replacement Wheels for carry-in sweeps and Powersweeps

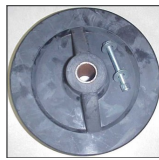

|                      |   |            |               |
|----------------------|---|------------|---------------|
| <b>702-00-0010</b>   | <b>6 7/8" for 5" screw, 2"w x 1" Bore</b> | <b>8#</b>  | <b>\$ 105</b> |
| <b>902-00-0010</b>   | <b>9 3/8" for 7" screw, 2"w x 1" Bore</b> | <b>10#</b> | <b>\$ 118</b> |
| <b>102-00-0010</b>   | <b>11" for 9" screw, 2"w x 1" Bore</b>    | <b>12#</b> | <b>\$ 115</b> |
| <b>802-00-1001RW</b> | <b>12" for 5:1 Reduction Wheel</b>        | <b>12#</b> | <b>\$ 115</b> |
| <b>802-00-1003RW</b> | <b>20" for 10:1 Reduction Wheel</b>       | <b>20#</b> | <b>\$ 178</b> |

## (5:1) & (10:1) Reduction Wheel for 8" & 10" Powersweeps 5:1 is best for 36' and under / 10:1 is best for 42' and up

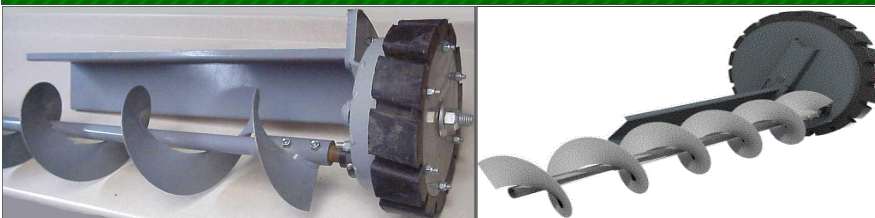

|                    |   |                 |
|--------------------|---|-----------------|
| <b>802-00-1001</b> | <b>5:1 Reduction Wheel End Drive Kit-12" Wheel</b>  | <b>\$ 704</b>   |
| <b>802-00-1003</b> | <b>10:1 Reduction Wheel End Drive Kit-20" Wheel</b> | <b>\$ 1,094</b> |

**A&S Ag Sales**  
27411 370th St NW  
Argyle, MN 56713

**1-218-437-8200**  
or  
**1-218-689-5983**

Prices subject to  
change without notice.

# Grain Saver U-Trough (Powersweep Unload Systems)

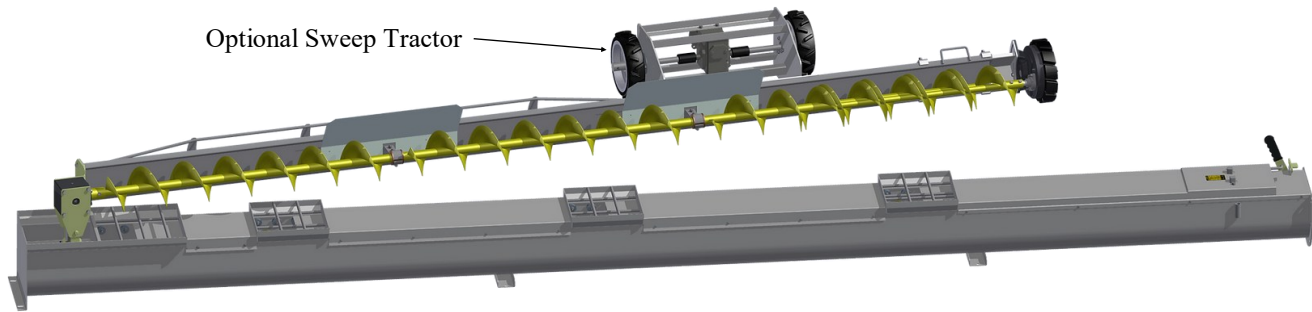

|          |         | 8" U-Trough  |     |          | 10" U-Trough |      |          |
|----------|---------|--------------|-----|----------|--------------|------|----------|
| Bin Dia. | Hoppers | Part #       | Wt. | Price    | Part#        | Wt.  | Price    |
| 19'      | 2       | 802-19-1102U | 338 | \$ 3,750 | 102-19-1102U | 515  | \$ 3,855 |
| 21'      | 2       | 802-21-1102U | 369 | \$ 3,920 | 102-21-1102U | 542  | \$ 4,070 |
| 24'      | 2       | 802-24-1102U | 395 | \$ 4,170 | 102-24-1102U | 565  | \$ 4,300 |
| 27'      | 2       | 802-27-1102U | 417 | \$ 4,390 | 102-27-1102U | 610  | \$ 4,570 |
| 30'      | 3       | 802-30-1103U | 446 | \$ 4,720 | 102-30-1103U | 646  | \$ 4,890 |
| 33'      | 3       | 802-33-1103U | 477 | \$ 4,900 | 102-33-1103U | 698  | \$ 5,080 |
| 36'      | 3       | 802-36-1103U | 510 | \$ 5,310 | 102-36-1103U | 755  | \$ 5,380 |
| 42'      | 4       | 802-42-1104U | 588 | \$ 6,045 | 102-42-1104U | 868  | \$ 6,425 |
| 48'      | 4       | 802-48-1104U | 635 | \$ 6,560 | 102-48-1104U | 958  | \$ 6,980 |
| 54'      | 4       | 802-54-1104U | 682 | \$ 7,445 | 102-54-1104U | 1129 | \$ 7,890 |
| 60'      | 5       | 802-60-1105U | 750 | \$ 7,990 | 102-60-1105U | 1400 | \$ 8,470 |

Must take delivery in a timely manner.

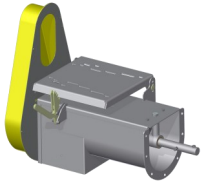

## Horizontal Powerheads

The innovative motor mount is the easy off style and has the over center belt tightener as standard. The 2-belt cast aluminum driven sheave, the drive belt(s), and the belt guard are all included.

| 8" Horizontal Powerhead |     |        | 10" Horizontal Powerhead |     |        |
|-------------------------|-----|--------|--------------------------|-----|--------|
| Part #                  | Wt. | Price  | Part #                   | Wt. | Price  |
| 802-00-1102U            | 94  | \$ 870 | 102-00-1102U             | 115 | \$ 960 |



## 22 Degree Inclined Powerheads

Inclined Powerheads are complete with electric motor mount, driven pulley, drive belts and drive shields. Support Stands are at an extra cost.

| DESCRIPTION                       | PART#        | Wt. | Price    |
|-----------------------------------|--------------|-----|----------|
| 8" U-Trough Inclined Powerhead    | 802-81-4002U | 166 | \$ 1,500 |
| 10" U-Trough Inclined Powerhead   | 102-11-4002U | 216 | \$ 1,780 |
| 10" to 12" Inclined Support Stand | 102-IS-4002U | 30  | \$ 265   |



Unload U-Troughs with Powersweeps are also available.

Call for pricing.

Freight: F.O.B Argyle, MN

218-437-8200 Office

218-689-5983 Cell

# Half Round Aeration



| Part Number | 20" ARCH Description  | Wt. | Price  | Part Number | 30" ARCH Description             | Wt. | Price  |
|-------------|-----------------------|-----|--------|-------------|----------------------------------|-----|--------|
| T1208       | Transition-12" Round  | 15  | \$ 351 |             |                                  |     |        |
| T1209       | Transition-18" Round  | 27  | \$ 442 | T1801       | Transition-18" Round             | 26  | \$ 408 |
| T1202       | Solid End Cap         | 4   | \$ 60  | T1802       | Solid End Cap                    | 8   | \$ 86  |
| 9739748     | Solid 4' Section      | 22  | \$ 134 | 9739839     | Solid 4' Section                 | 30  | \$ 179 |
| 9739730     | Perforated 4' Section | 20  | \$ 114 | 9739756     | Perforated 4' Section            | 28  | \$ 141 |
| T1211       | 4 Way Cross           | 20  | \$ 260 | T1811       | 4 WC (req. 1 perf duct & 2 caps) | 54  | \$ 479 |
| T1212       | Y                     | 14  | \$ 209 | T1815       | Y                                | 27  | \$ 312 |

## AGI 25" ARCH Half Round Kits (everything you need in one kit)

| Part Number | Description                                  | Wt. | Price   |
|-------------|--|-----|---------|
| 196232      | Aeration Duct Kit 25" In-line for 14-15' Bin | 116 | \$ 1000 |
| 196233      | Aeration Duct Kit 25" In-line for 18-21' Bin | 140 | \$ 1170 |
| 196234      | Aeration Duct Kit 25" V-shape for 14-15' Bin | 168 | \$ 1310 |
| 196235      | Aeration Duct Kit 25" V-shape for 18-21' Bin | 220 | \$ 1600 |

0.054 Perforated openings, so will work for Canola.  
Individual parts are also available and can be purchased without a kit purchase.

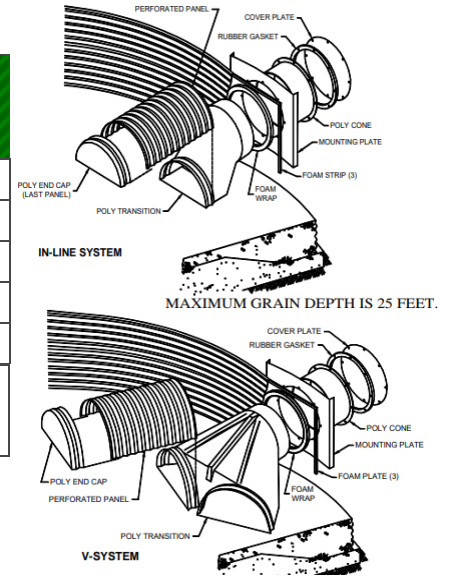

Prices subject to change without notice.

[www.asagsales.com](http://www.asagsales.com)

## FARM SUPPLIES



Bin Ladders  
32" & 44"



Bin Seal



Silicone  
Sealant



Fits 6"-10" Augers



Fits 8"-13" Augers



Grain Port



Quick Clamp



Fan Covers

| Part #   | Qty Order | Description | Size      | Price  |
|----------|-----------|-------------|-----------|--------|
| 32-3     |           | ladder      | 32"       | \$ 74  |
| 44-3     |           | ladder      | 44"       | \$ 88  |
| DC-1     |           | bin seal    | 5 gal     | \$ 370 |
| DC-1PF   |           | poly fabric | 4" x 300' | \$ 75  |
| AD9495   |           | silicone    | 10 oz     | \$ 10  |
| T1290    |           | quick clamp | 12"       | \$ 77  |
| T1490    |           | quick clamp | 14"       | \$ 88  |
| T1890    |           | quick clamp | 18"       | \$ 105 |
| T2490    |           | quick clamp | 24"       | \$ 117 |
| T1298A   |           | fan cover   | 12"       | \$ 50  |
| T1898A,B |           | fan cover   | 18"       | \$ 80  |
| T2498A,B |           | fan cover   | 24"       | \$ 123 |
| T2898A,B |           | fan cover   | 28"       | \$ 152 |
| T1102    |           | grain port  | 18"       | \$ 313 |
| MPH      |           | Poly Hopper | Triangle  | \$ 205 |
| BPH      |           | Poly Hopper | Round     | \$ 263 |



**Your Full-Service Supplier  
for  
Grain Bins,  
Farm Supplies and  
Storage Related Products**

**Hello Valued Customer,**

Entering into 2026, we are committed to doing our part to help you have a productive and successful year. We were able to secure better programs with some suppliers and are passing along those savings to you!

Therefore, pricing on most all catalog items have reduced by 5% from last year.

Also, the Canadian tariffs are still ongoing and we have decided to keep absorbing those additional costs, so pricing on those products stayed the same from last year.

As always, we desire to provide quality products and service at competitive prices!

Sincerely,

Travis Anderson

and

Reece Setterholm

**We are adding to our team,**

**If you live in the tri-state region (MN, ND and SD) and want to have  
a career in Sales or Customer Service, then please  
call us! Working from your home and  
part-time positions are  
also available.**

1-218-437-8200 Office

Call us at:

1-218-689-5983 Cell